

particolare 1

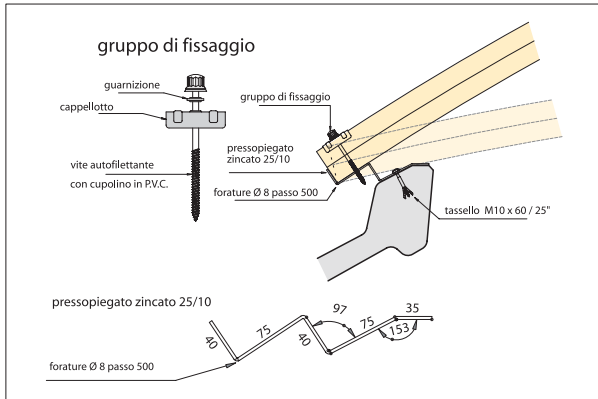

particolare 2

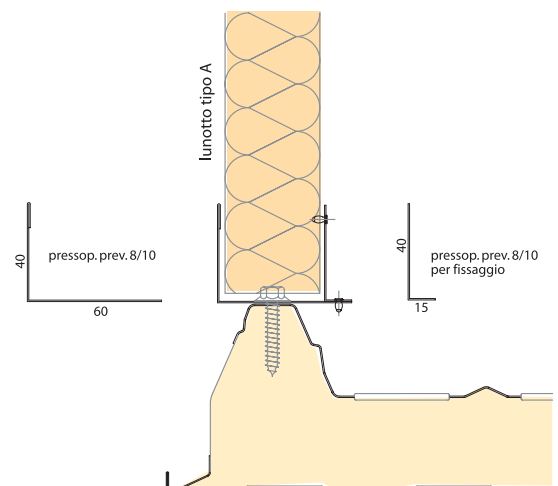
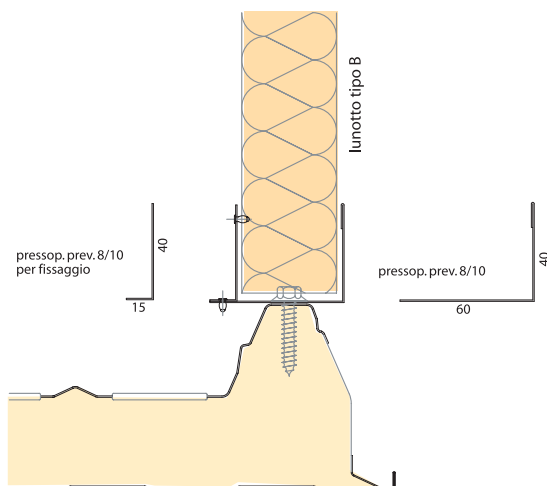
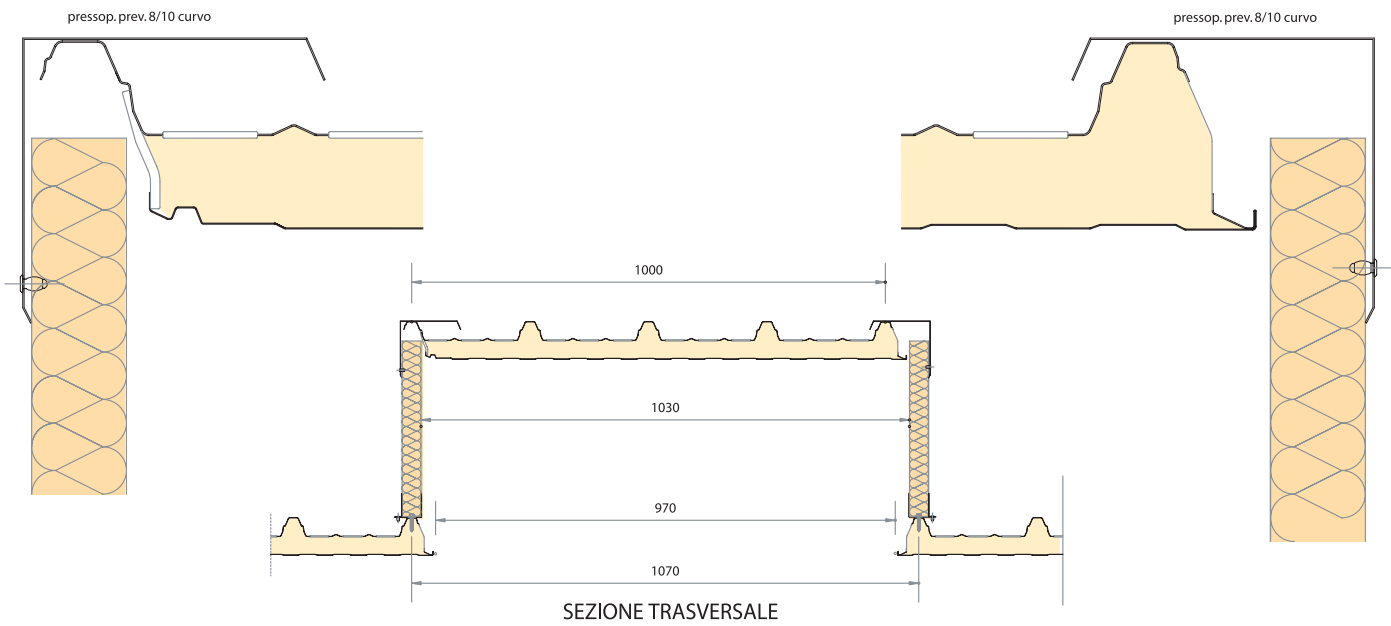
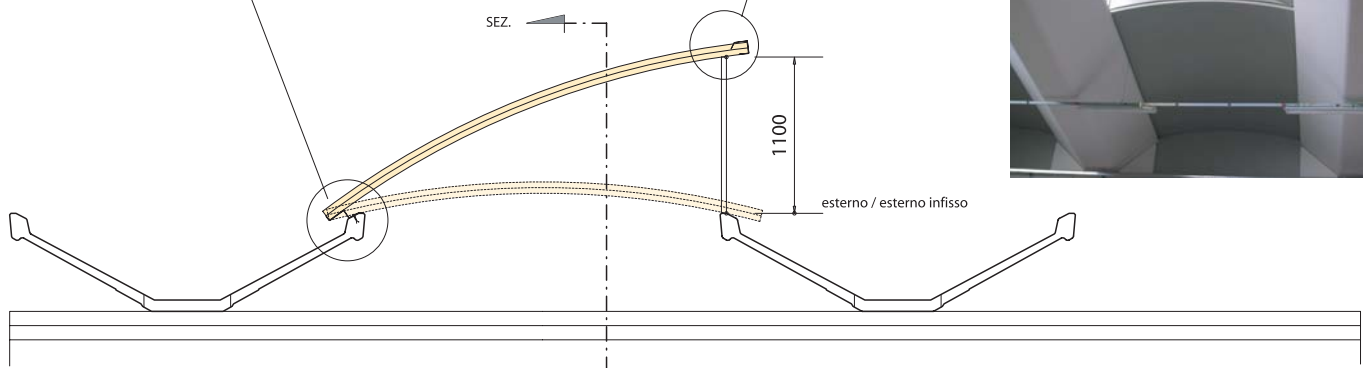
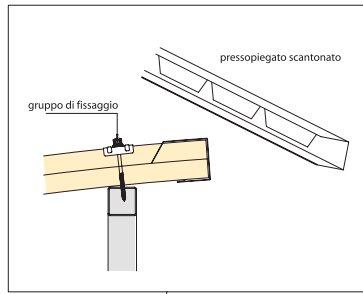

POLICARBONATO / POLICARBONATO



espansolene sagomato arcoplus

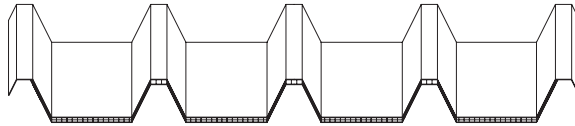

lastra curva in policarbonato tipo "ARCOPLUS"

rete elettrosaldata Ø 2.2 maglia 50 x 75

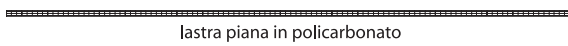

lastra piana in policarbonato

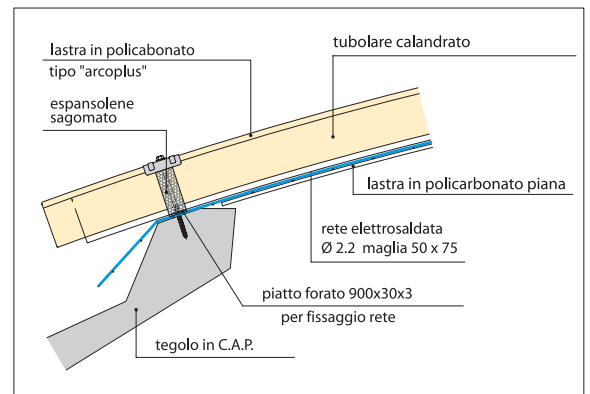
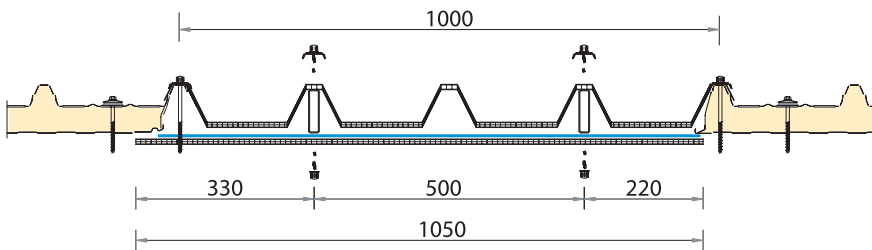

fissaggio rete

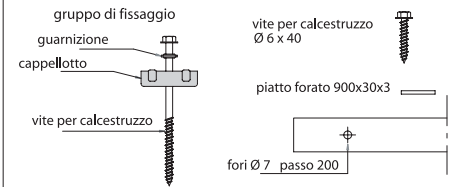

VETRORESINA / POLICARBONATO

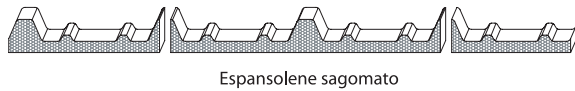

Espansolene sagomato

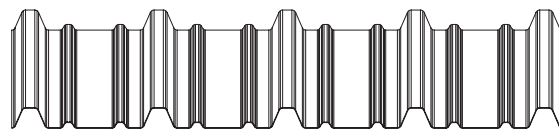

lastra in vetroresina

rete elettrosaldata Ø 2.2 maglia 50 x 75

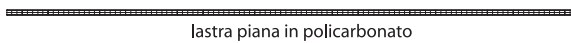

lastra piana in policarbonato

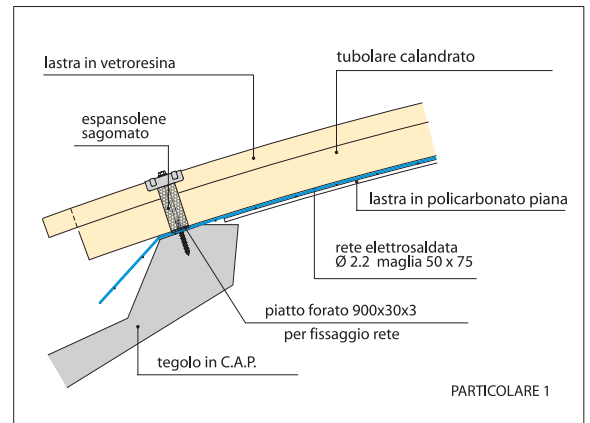
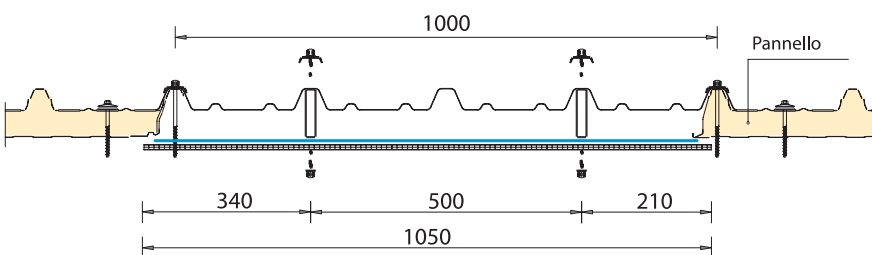

fissaggio rete

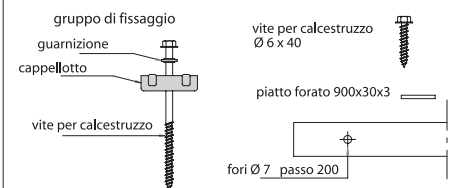

VETRORESINA / VETRORESINA

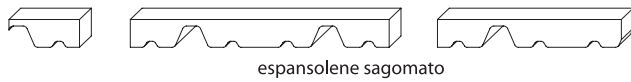

espansolene sagomato

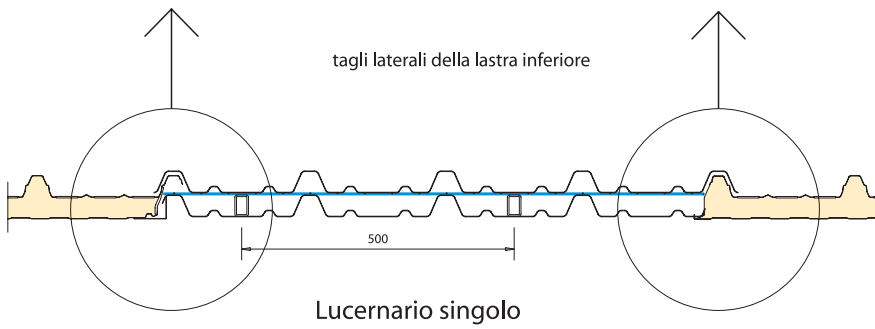
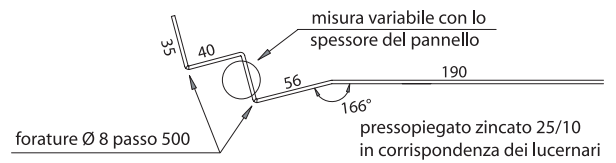
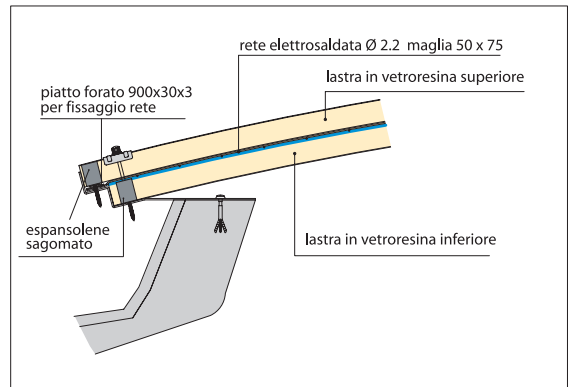
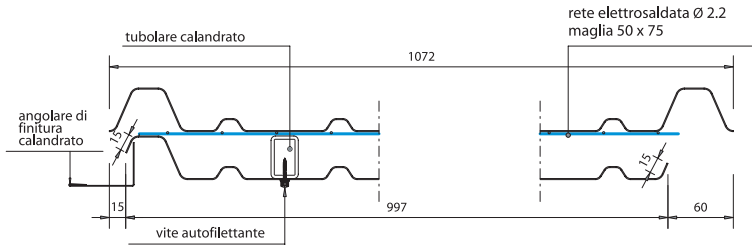

Lucernario singolo

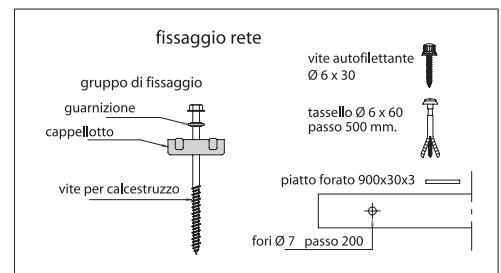

I dati sopra riportati si fondano sulle ns. conoscenze tecniche e su ns. prove sperimentali. L'Italpannelli si riserva il diritto di apportare alla propria produzione modifiche e/o miglioramenti ritenuti necessari a suo insindacabile giudizio. Tali dati non hanno il significato di garanzia di qualità non avendo la Italpannelli nessun controllo diretto sulle condizioni di impiego.

The data above derive from our technical knowledge and on test we performed. The Italpannelli deserves the right to make changes or improvement in the production that are considered necessary, according to its unquestionable decision. These data cannot be taken as a guarantee of quality, due to the fact the Italpannelli can have no control on how the panels are used.